



Noel Matthews – G8GTZ
Dave Crump – G8GKQ





Topics

- BATC Oscar 100 overview
- BATC Why is it a game-changer?
- BATC What does it offer?
- BATC How do I get started?
- BATC Narrow band operation
- BATC Wide band operation
- BATC The WebSDR

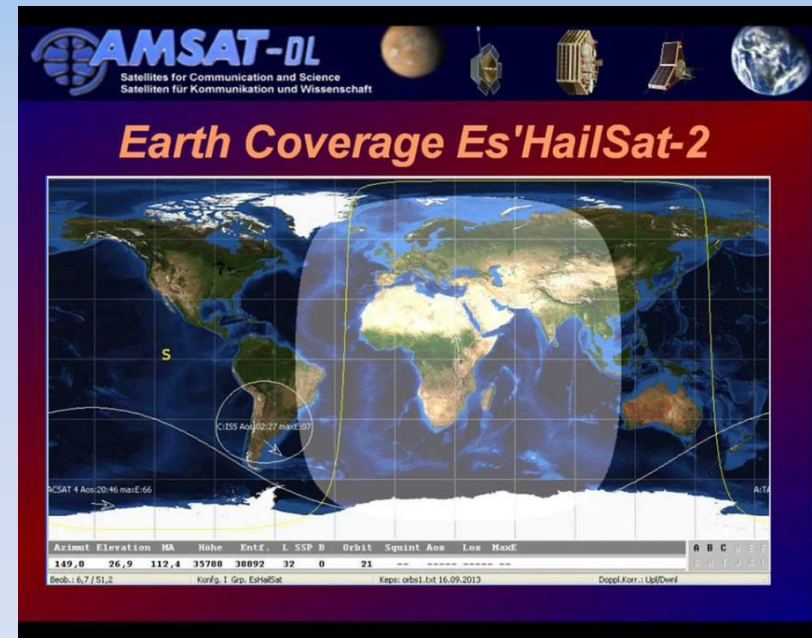

What is Oscar 100

-  Oscar 100 is 2 amateur radio transponders hosted on the Es'hail-2 Direct Broadcast TV satellite
-  Owned by Es'hailSat in Qatar.
-  Built by Mitsubishi Electric Company (MELCO) in Japan.
-  Collaborative project with Es'hailSat / AMSAT-DL / Qatar ARS
-  The first ever amateur payload on a commercial geostationary satellite





BATC

Oscar 100



 Project started in 2012
by Qatar Amateur Radio
Society and AMSAT DL

 Launched by SpaceX
Falcon 9 from Cape
Canaveral

– November 2018

 Commissioned and ready
for use in February 2019



Es'hail (Canopus) is the name of a star which becomes visible in the night sky of the Middle East as summer turns to autumn.



Es'hail-2

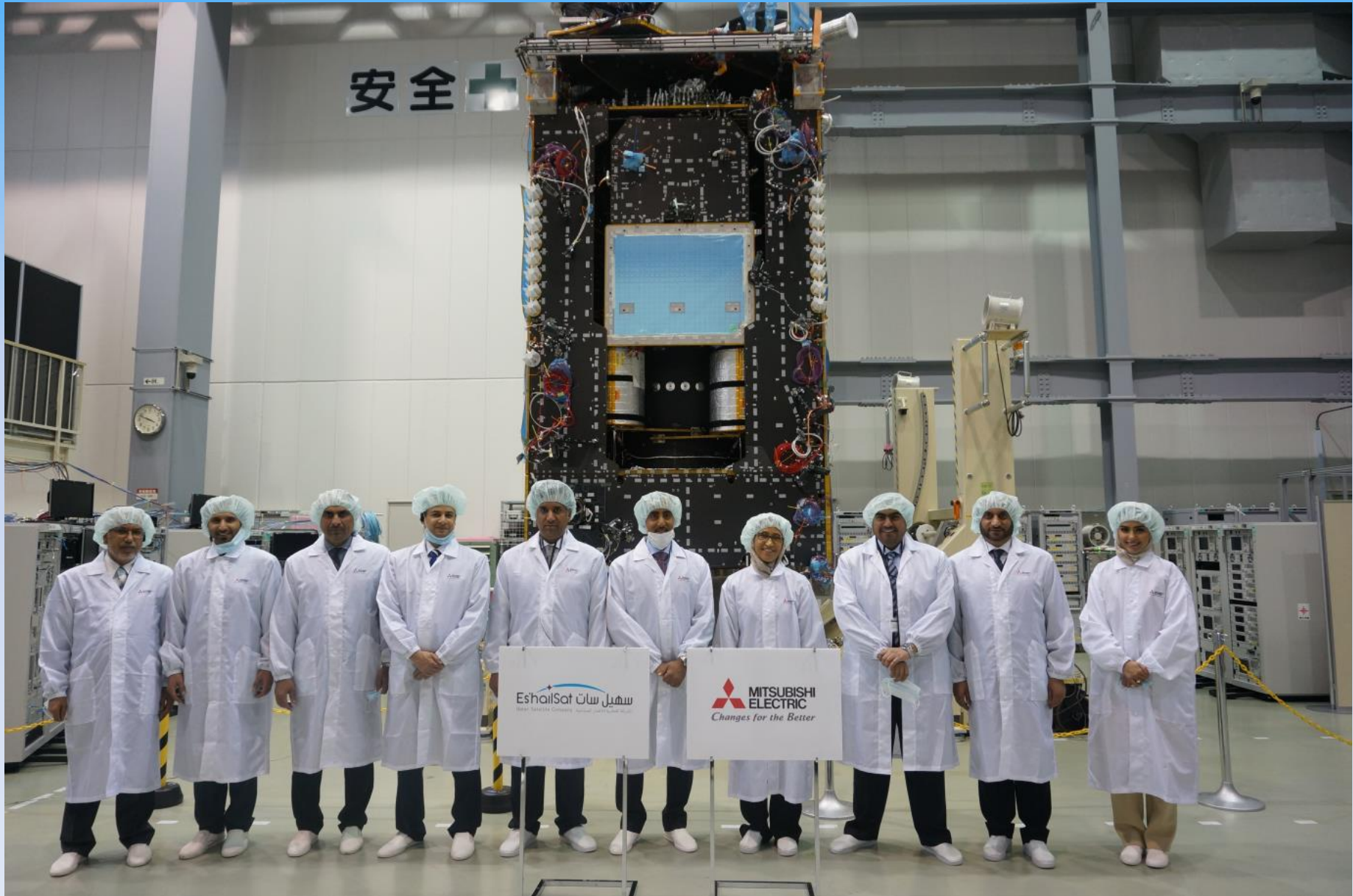

FUNcube-1 CubeSat AO-73



Based on a 10cm x 10cm x 10cm format.
- approximately 900g

European Student Earth Orbiter (ESEO)

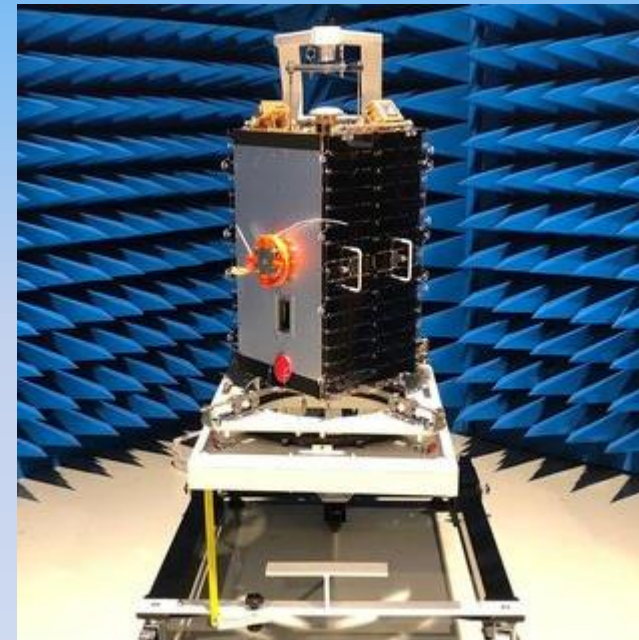

MicroSat - 50kg

Orbits and coverage

-  **Low Earth Orbit**
 - Typically 400 – 700km altitude
 - Orbit once every 90 minutes = tracking

-  **Medium Earth Orbit**
 - 8000km - 20,000km
 - Used by navigation satellites
 - No amateur satellites

-  **Geostationary**
 - 36,000km altitude
 - large coverage area – 40% of the earth and 60% of population
 - No antenna tracking needed
 - Where all broadcast TV satellites are





36,000 Km altitude

-3dB Beamwidth = 17.4° \rightarrow $\sim 20\text{dB}$ Antenna Gain !!

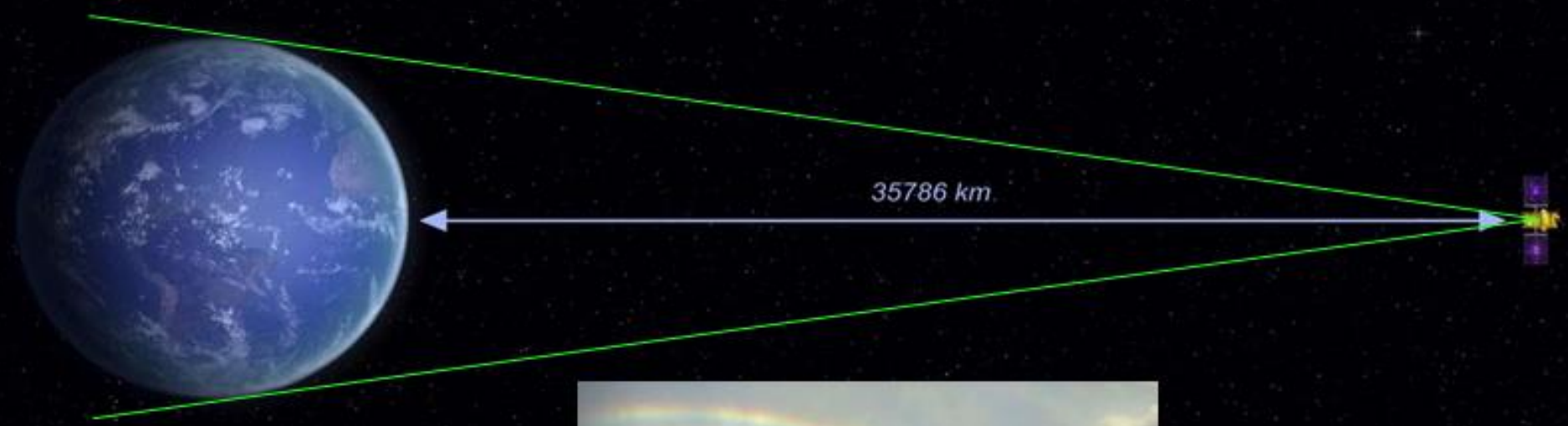



Earth Coverage Es'HailSat-2

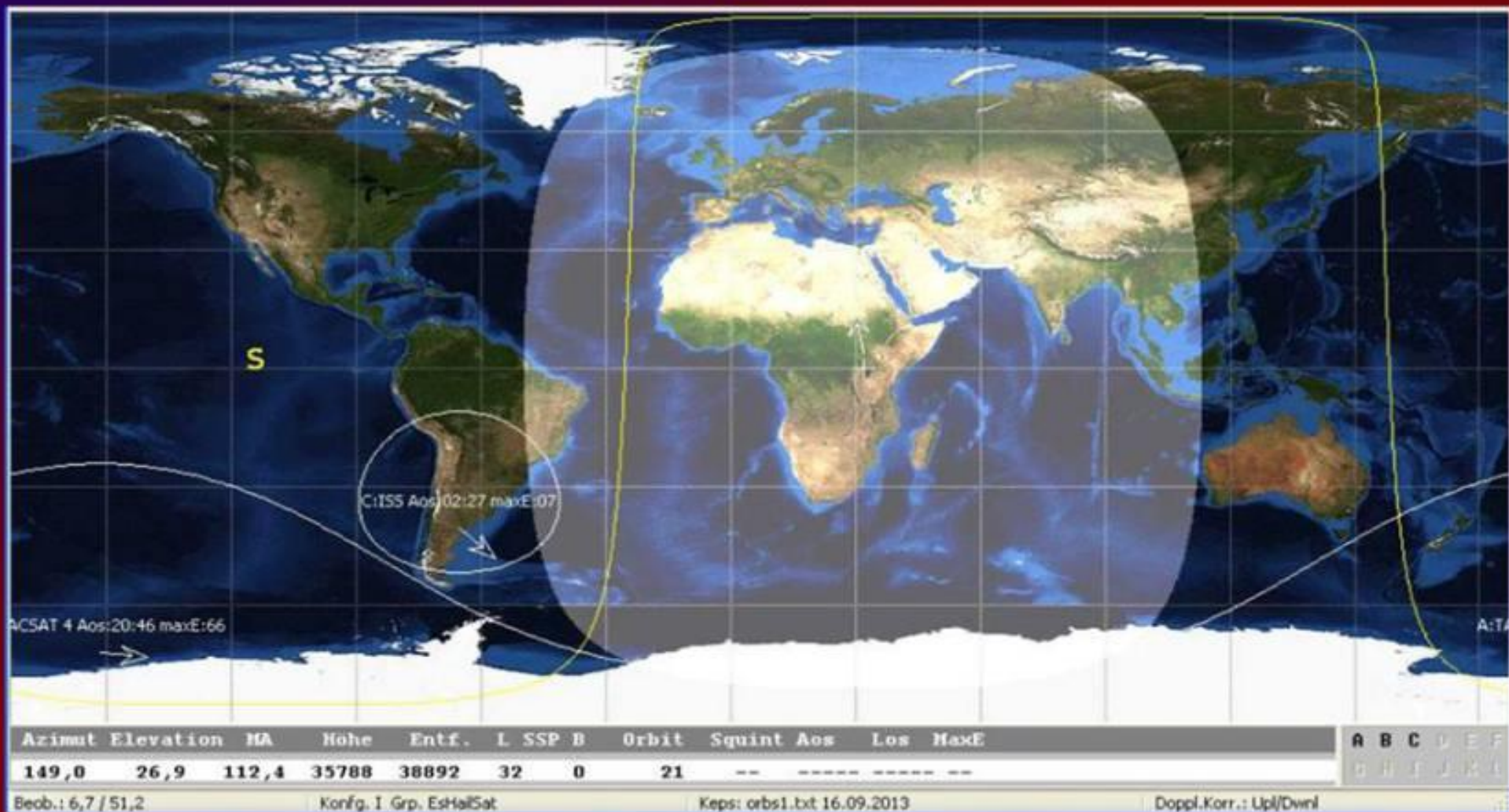

What is on Oscar100?

2 transponders dedicated to Amateur Radio

- 13cms (2400MHz) uplink
- 3cms (10GHz) downlink

Narrow band transponder 250kHz wide

- CW, SSB data modes etc
- AGC and Leila over power warning system
- CW and BPSK beacons

Wide band transponder 8MHz wide

- Dedicated to Digital modes
- Primarily Digital Amateur Television
- Up to 8 DATV signals simultaneously
- HD beacon channel





Narrowband Band plan

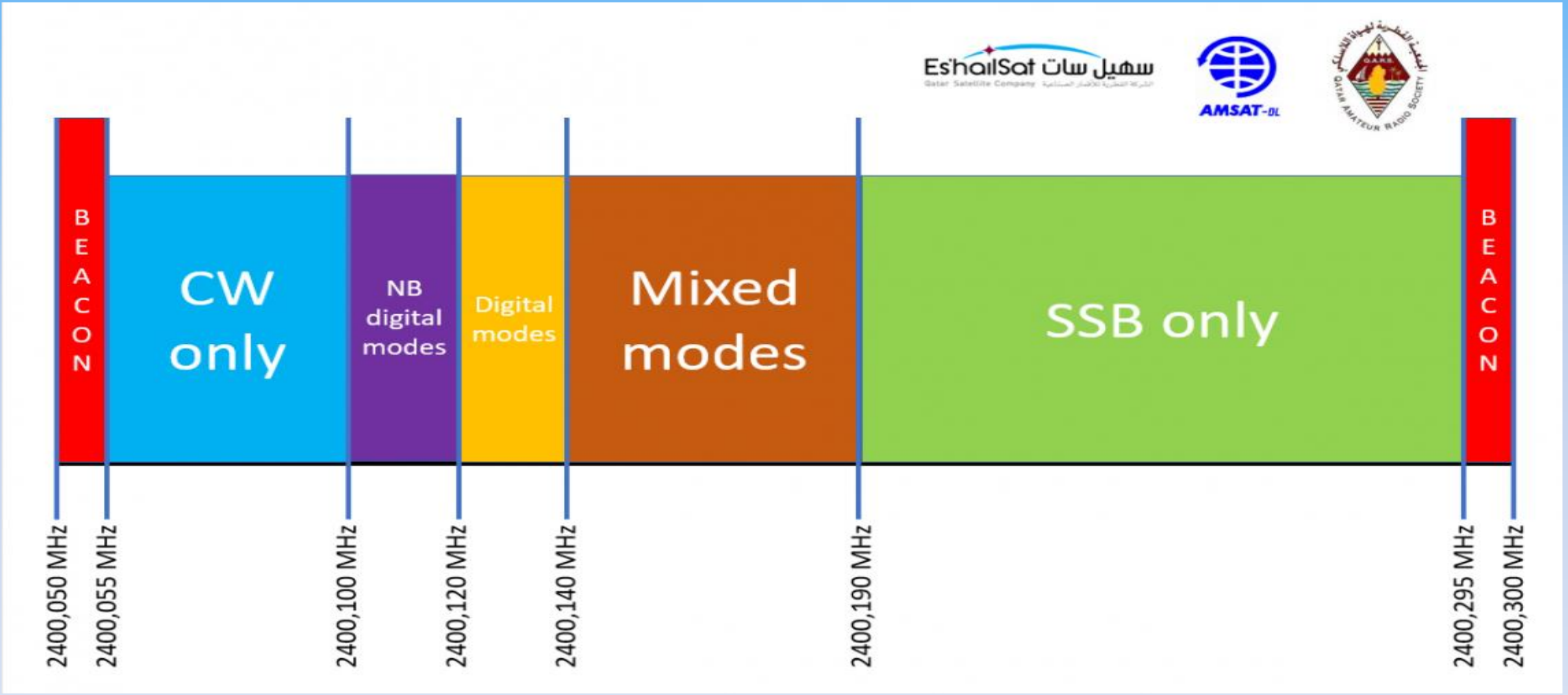





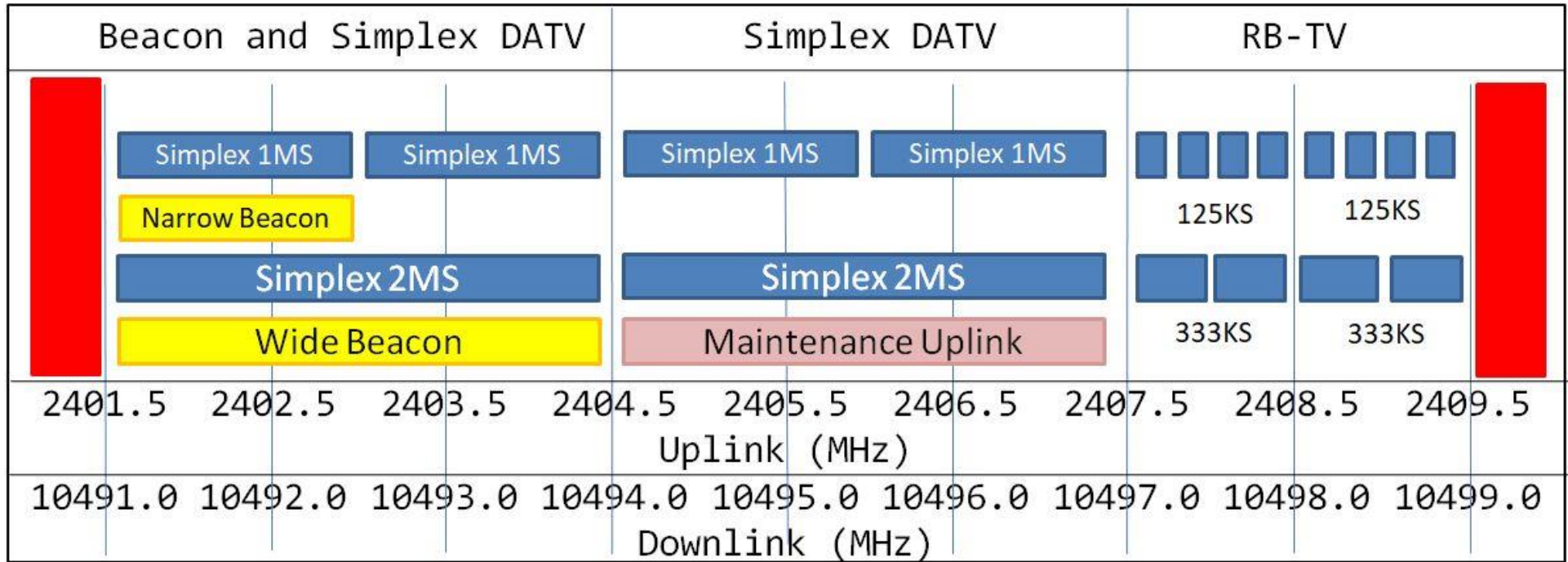

Wideband band plan





How do I get started?

-  Whether going for Narrow band or Wide Band DATV – start with receive...
-  Satellite dish pointing at 26 degrees
 - 60cms (Sky) for NB
 - 90cm - 1.2m for DATV
-  <https://eshail.batc.org.uk/point/>
 - Just south of Sky/Freeview
-  Use a new PLL LNB for greater stability
 - Available for approximately £10



Is it this simple?

-  Yes!
-  A simple NB rx system is:
 - Sky dish
 - New PLL LNB
 - ~ £10 RTL dongle or Funcube, LimeSDR or Pluto
-  Bias Tee to supply 12v
-  Free SDR software
 - SDR#
 - SDR Console
-  Tune to the IF frequency of 739 MHz

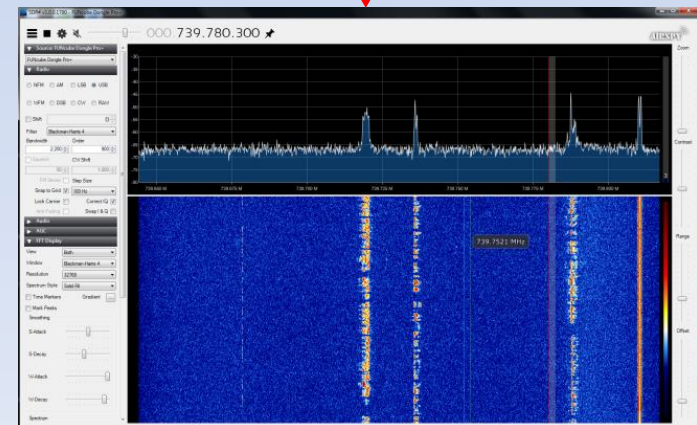
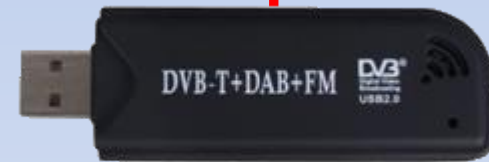



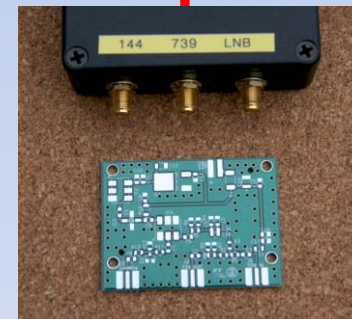

Can I use a VHF / UHF rig?

- Yes – but...
- The output from the LNB is 739MHz
- A downconverter will shift this to 432 or 144MHz
- Frequency stability is an issue
 - Lock all oscillators to external ref
 - Use SDR locking



NB Transmitting - 1

-  The NB transponder is VERY sensitive
-  Transvert up from a VHF or UHF rig
-  Small PA ~ 4 watts
 - wi-fi booster
-  LHCP helix dish feed
-  Separate dish or dual band patch feed



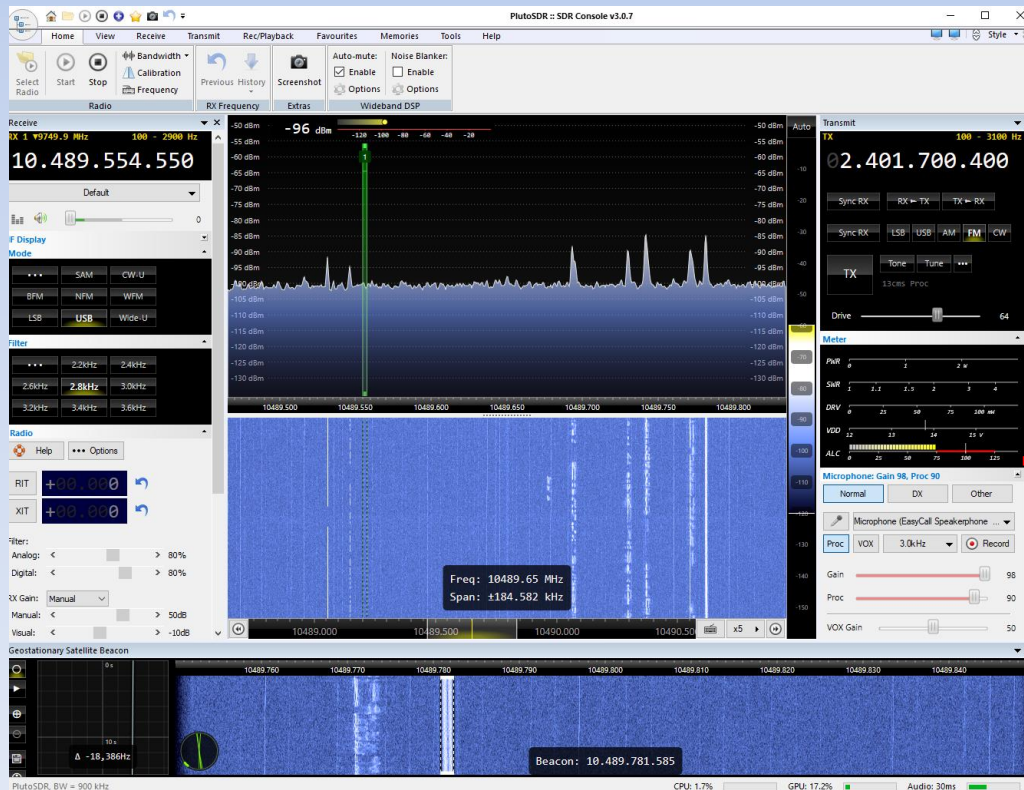

NB transmitting - 2

- SDRconsole by G4ELI
- Tx and Rx via Pluto or LimeSDR
 - Full duplex
 - Frequency lock to BPSK beacon





NB operation

-  All modes permitted
-  Digital, SSB, CW, Hellschreiber....
-  Great for experimentation and easy to receive

 DL7NX

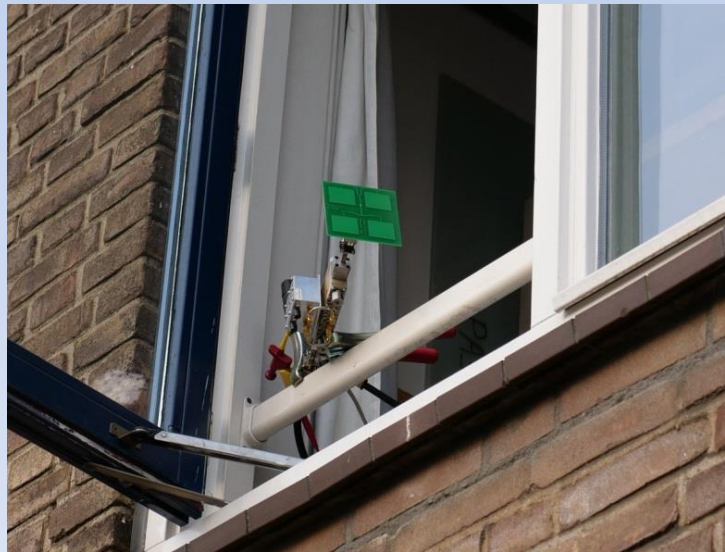
- 1 watt to 4 ele PCB Yagi.





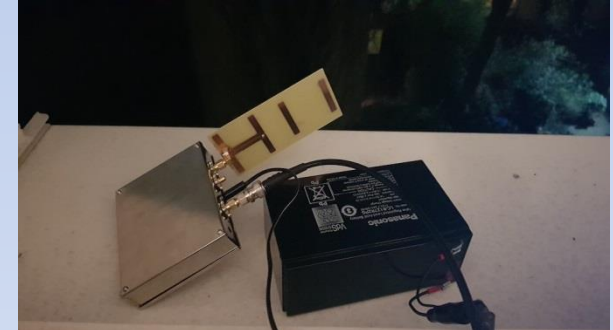

 PA3WEG

- 1 watt to a PCB quad patch







Oscar 100 Wideband

-  Oscar 100 wideband is an “8 MHz bent pipe” transponder for wideband digital use
-  Occupied bandwidths can be 200 kHz – 8 MHz
-  Most signals are <1MHz wide
-  Some experiments below 100Khz
-  DVB-S2 with H264 / H265 video





Receiving DATV

-  Downlink frequency is 10,491 – 10,499 MHz and within pass band of standard consumer LNB
-  PLL LNBS should be used to give stability for Reduced Bandwidth TV signals
 -  Locking can cause phase noise problems
-  However 9,750 MHz LO puts IF outside consumer set top box tuning
-  90% of signals are Reduced Bandwidth (RB-TV) and cannot be received on a consumer STB



MiniTioner USB tuner

- A wide frequency range tuner
 - Covers 143 – 2450 including 741 MHz
- Available as kit or built unit
- PC based with software by F6DZP
 - Gives totally flexible receive system
 - MPEG-2, H264 and H265
 - 33Ks to 27 Msymbols DVB-S, DVB-S2, for HD-TV, DATV and RB-TV



• See <https://batc.org.uk/>

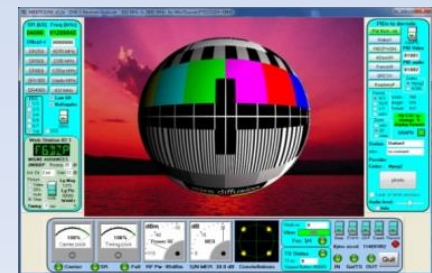

Receiving DATV

-  Aim for a 1m dish
-  Check your dish direction using
 - <https://eshail.batc.org.uk/point/>
-  Align using BADR-4 TV services
 - 12,597 MHz, 27500 Ms, Horizontal
 - ~11dB MER
-  Check the WB beacon
 - 2Ms DVB-S2
-  More details:
https://wiki.batc.org.uk/Receiving_Oscar_100_DATV_signals



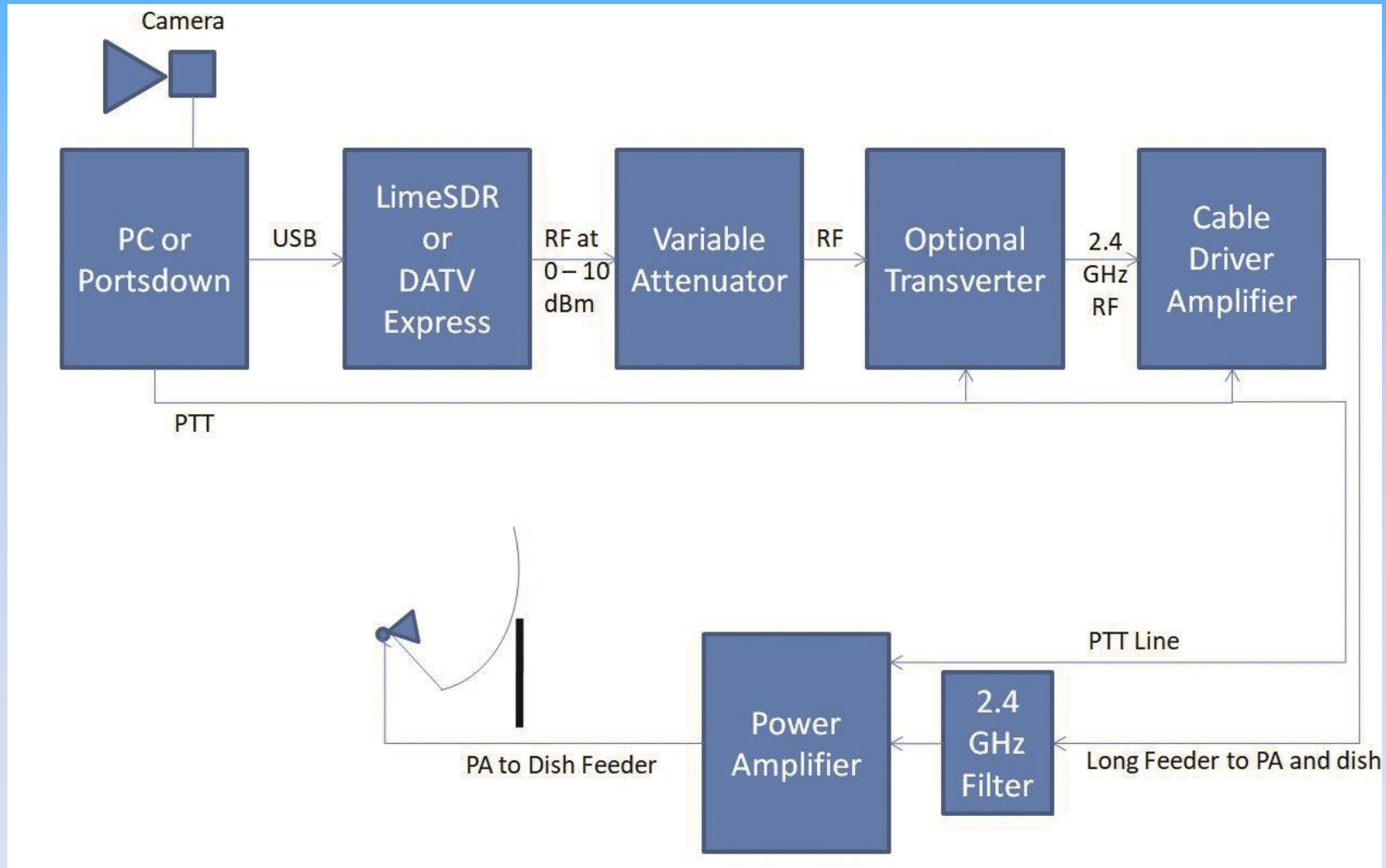

Dish size	Received MER
1.8m	10dB
1.2m	8dB
1m	6dB
80cm	5dB

DATV transmit system





DATV transmit

-  ~30 watts in to a 1.2m dish
-  PA at dish and VERY short feeder
-  Dual band dish feed
 - 2.4GHz patch
 - LNB 22mm waveguide





3 signals

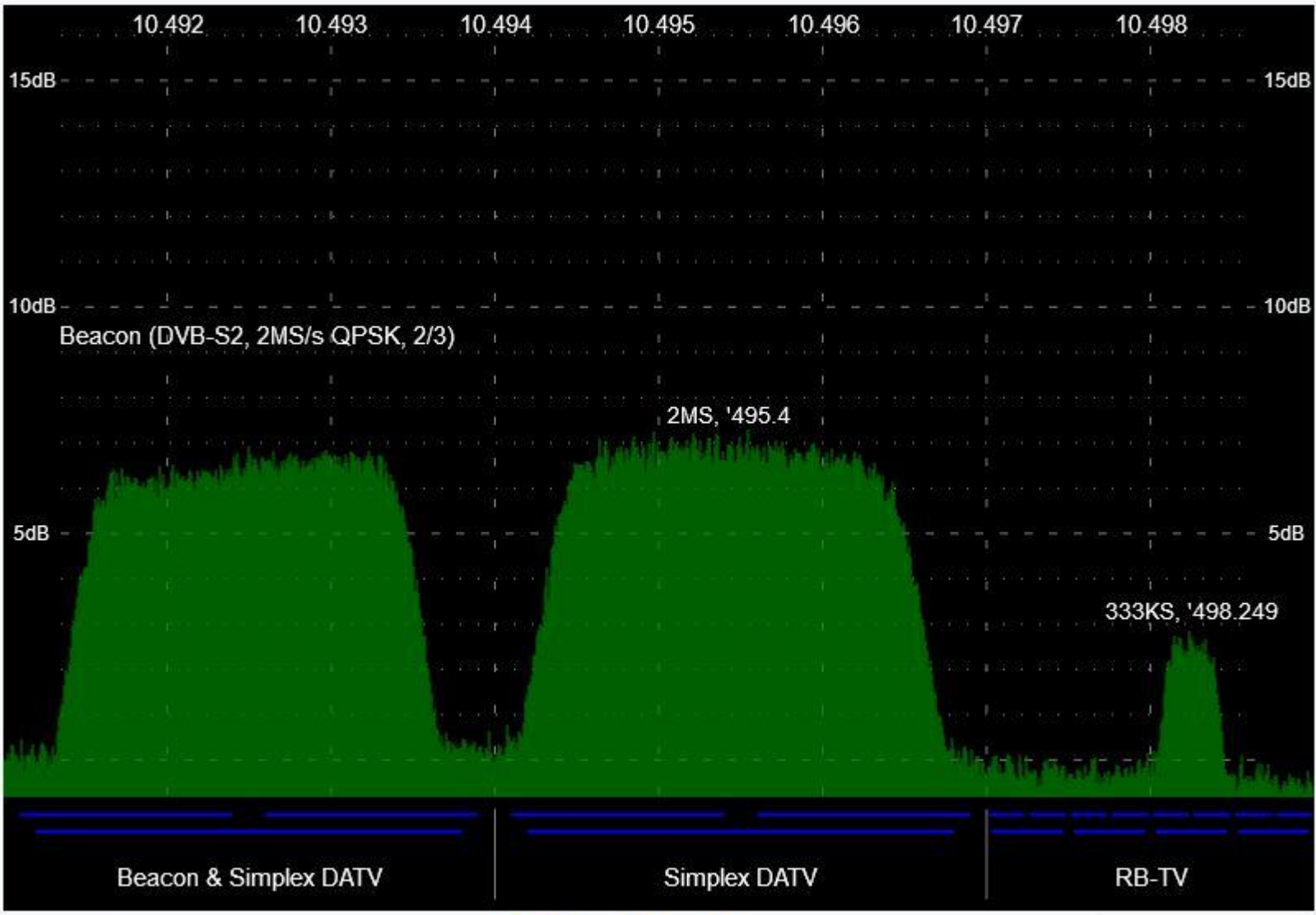

Users: 149

[DATV Bandplan Link](#)

Open fullscreen



G4EML ~ 300kHz





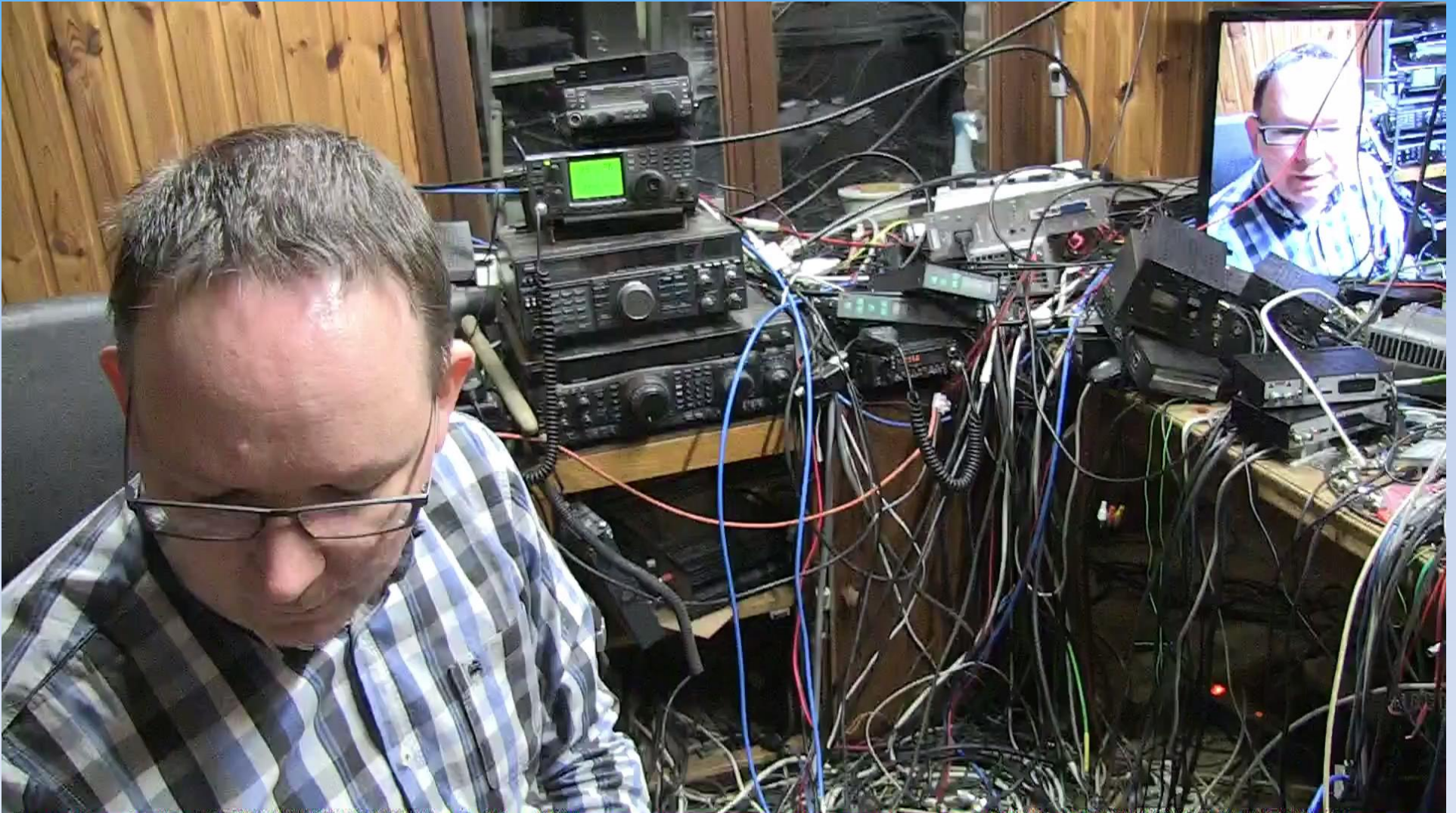

BATC

ON4BHM - 2MHz





The WebSDR

-  AMSAT-UK and BATC wanted to make Oscar 100 accessible to everyone
-  An on-line WebSDR which only needs a standard web browser
-  Full coverage of NB transponder with waterfall and full audio decode.
-  350+ users on first weekend

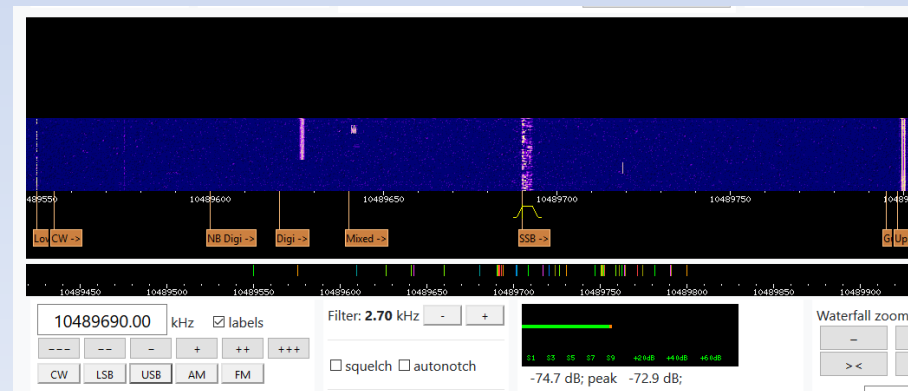



Spectrum Monitor

An essential tool to enable the Wide Band transponder usage

The screenshot displays a spectrum monitor interface with a frequency range from 10.492 to 10.498 MHz. The vertical axis shows signal strength in dB, ranging from 5dB to 15dB. Three signals are visible:

- Beacon (DVB-S2, 2MS/s QPSK, 2/3)**: A wide signal centered at 10.494756 MHz with a bandwidth of 0.9MS.
- Simplex DATV**: A signal centered at 10.496249 MHz with a bandwidth of 500KS.
- RB-TV**: A signal centered at 10.497751 MHz with a bandwidth of 250KS.

At the bottom of the spectrum view, there are three colored bars corresponding to the signal types: Beacon & Simplex DATV (blue), Simplex DATV (green), and RB-TV (red).

On the right side, there is a chat log with the following messages:

- 17:07 **i2NDT Claudio** OK DZP...I will wait :-)
- 17:07 **G7NTG_JIM** haha don't look down the waveguide!
- 17:07 **F6DZP** thanks JIM
- 17:08 **G0MJW** I don't like the PTFE lens – its much worse than the recommended polyfeed.
- 17:09 **G7NTG_JIM** looks like a nice kit – all you need is a blowlamp and solder
- 17:09 **i2NDT Claudio** by the way Jean Pierre myself and i2CIC are qorking on a very stable DRO LNB!
- 17:09 **i2NDT Claudio** working
- 17:09 **G7NTG_JIM** would this be locked to a reference?
- 17:10 **G7NTG_JIM** I use an octagon with a Leo Bodnar and it is great on the narrowband
- 17:11 **i2NDT Claudio** well...yes and no...just using a stable 10GHz external LO instead of the internal DRO
- 17:12 **on7ndr** nice pictures guy on the beacon frequency thanks
- 17:12 **G1LPS** KLB audio good
- 17:12 **G7NTG_JIM** I tried the ptfе lens but it did not improve either dish – I use a rocket lens on the narrowband 80cm dish which gives me 3dB more signal
- 17:12 **G0MJW** Yes – nice kit and well priced too
- 17:12 **G7NTG_JIM** I thought so
- 17:13 **G7NTG_JIM** he is out of stock at the moment!

At the bottom left, it says "Users: 169". In the center, there is a link "DATV Bandplan Link". At the bottom right, there is a button "Open fullscreen".

At the bottom of the chat log, there is a text input field with the placeholder "Type a message here and press enter."



BATC + AMSAT-UK SDR



Located at Goonhilly Earth Station

- Quiet secure location (I070JB)
- Excellent network connectivity
- Scaled for 500+ users



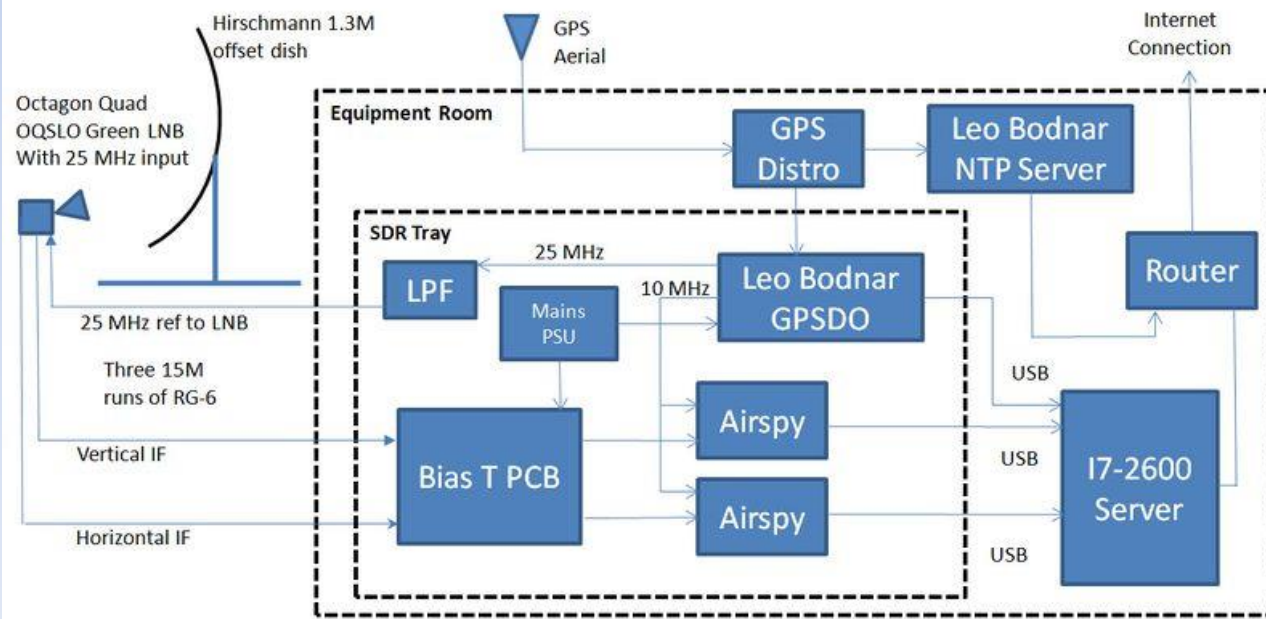

Goonhilly Es'hail-2 Spectrum Monitor and WebSDR - Hardware



Is it really amateur radio?



-  Absolutely - hundreds of people are engaged in that most vital aspect of amateur radio:
 - Self training in wireless telegraphy
-  It has breathed new life in to the satellite and microwave communities
-  As well as providing 24/7 communications to 1/3rd of the earth



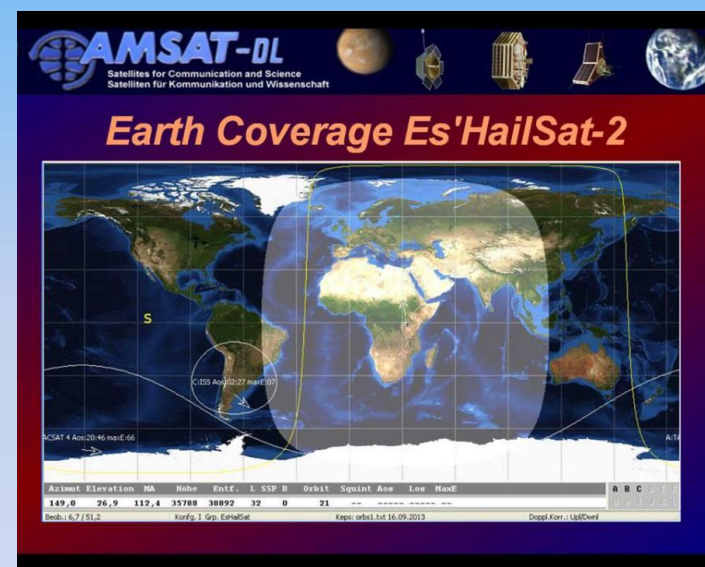

Conclusions

-  Oscar 100 is a fantastic opportunity for amateur experimentation
-  Receive is easy!
-  A good transmit capability is more of a challenge but not impossible!!
-  Start simple
 - Get a receiver working!





WebSDR demo

-  Usable by anyone with a web browser
 - Scaled to support 500 simultaneous users
-  All listening to different frequencies and decoding different modes!
-  Runs s/w developed by www.websdr.org
 - More than 150 systems around the world
-  <https://eshail.batc.org.uk/nb/>
-  Wideband spectrum monitor
 - <https://eshail.batc.org.uk/wb/>